

The Harman Kardon Model CD291

Manual No. 60C

ULTRAWIDEBAND LINEAR PHASE CASSETTE DECK

Technical Manual

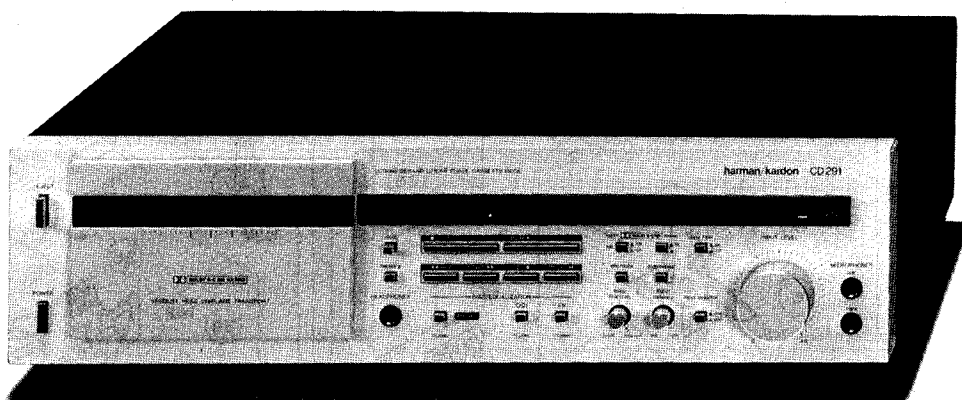

SUPPLEMENTARY MANUAL

THE CASSETTE MECHANISM WAS REVISED AT SERIAL NUMBER 9101. FOLLOWING IS THE COMPLETE PARTS LIST AND ASSEMBLY DRAWINGS OF THE REVISED CASSETTE MECHANISM. ALSO, SOME REVISIONS IN THE CIRCUITRY ARE INCORPORATE. REFER TO TECHNICAL MANUAL NO. 60A FOR ALL OTHER REPLACEMENT PARTS AND SERVICE INFORMATION EXCEPT FOR THE CHANGES AS NOTED IN THIS SUPPLEMENT.

harman/kardon

240 CROSSWAYS PARK WEST, WOODBURY, N.Y. 11797
1112-H15260C7 P-088412 1650 PRINTED IN JAPAN

CASSETTE MECHANISM EXPLODED VIEW

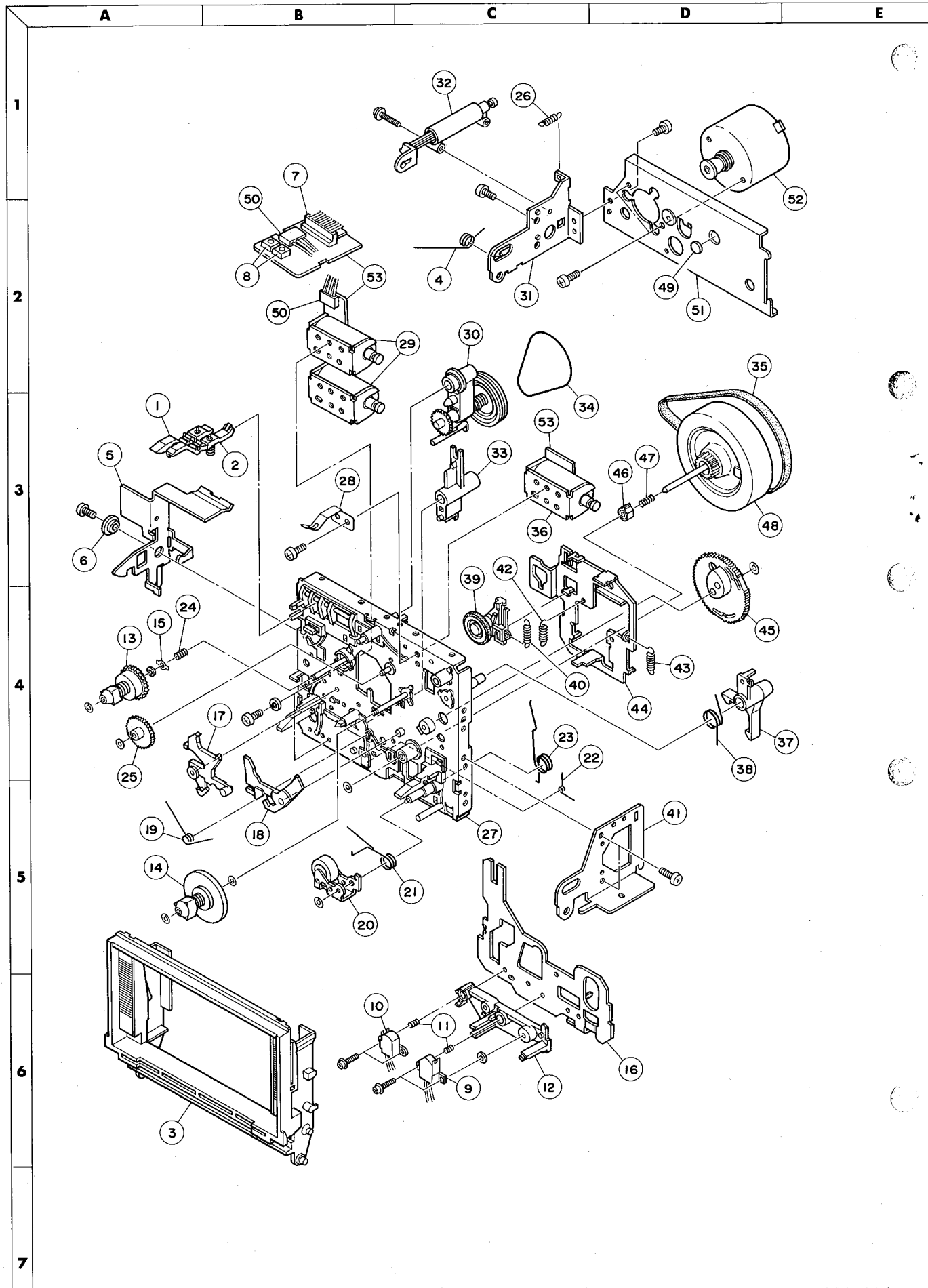

CD291

CASSETTE MECHANISM PARTS LIST

Ref. No.	Part No.	Description
1	F245-011	Record Arm
2	F244-011	Switch Arm
3	FD28S-14	Cassette Support
4	FK568-11	Spring, Door
5	FC30K-11	Eject Lock Arm
6	FM296-11	Spacer
7	KY130-11	Connector, 8-Pin
8	UE13K-11	Switch
9	FU161-13	Head, Record/Playback
10	FU192-11	Head, Erase
11	FK572-11	Spring, Azimuth
12	FD23C-13	Spacer, Head
13	F105-020	Supply Reel Assembly
14	F123-026	Take-up Reel Assembly
15	FC29K-11	Spring Holder
16	FC29N-13	Head Base
17	FD24H-12	Brake Arm (L)
18	FD24K-12	Brake Arm (R)
19	FK18U-11	Spring, Brake
20	F014-075	Pinch Roller
21	FK18S-11	Spring, Pinch Roller
22	FK18V-11	Spring, Solenoid Arm
23	FK18T-14	Spring, Assist
24	FK11F-47	Spring, Back Tension
25	FN14B-12	Idler Gear
26	FK18M-11	Spring, Eject Lock Arm
27	F011-163	Chassis Assembly
28	FC29E-11	Spring, Cassette
29	PKA16112	Solenoid, F. FWD, REW.
30	FR17M-13	Clutch Assembly
31	FC29F-11	Bracket, Dumper
32	FP472-11	Dumper Assembly
33	FD23B-12	F. FWD/REW. Solenoid Arm
34	FP463-11	Sub-Belt
35	FF14A-11	Main Belt
36	PKA16113	Solenoid, Play
37	FD23E-12	Play Arm
38	FK18W-12	Spring, Play Arm
39	FR17N-11	Idler Assembly
40	FK18R-11	Spring, Idler
41	FC29G-11	Bracket, Door
42	FK18N-11	Spring, Head Base
43	FK18P-11	Spring, Assist Base
44	FC29M-12	Assist Base
45	FN14C-12	Play Gear
46	FD24G-12	Collar
47	FK11F-51	Spring, Flywheel
48	FR17E-11	Flywheel Assembly
49	UJ11S-11	Spacer
50	WH20C-01	Connector with Lead Wire, 4-Pin
51	FC29H-15	Bracket, Motor
52	F064-129	Motor
53	FP12T-12	Connector Panel

GENERAL UNIT EXPLODED VIEW

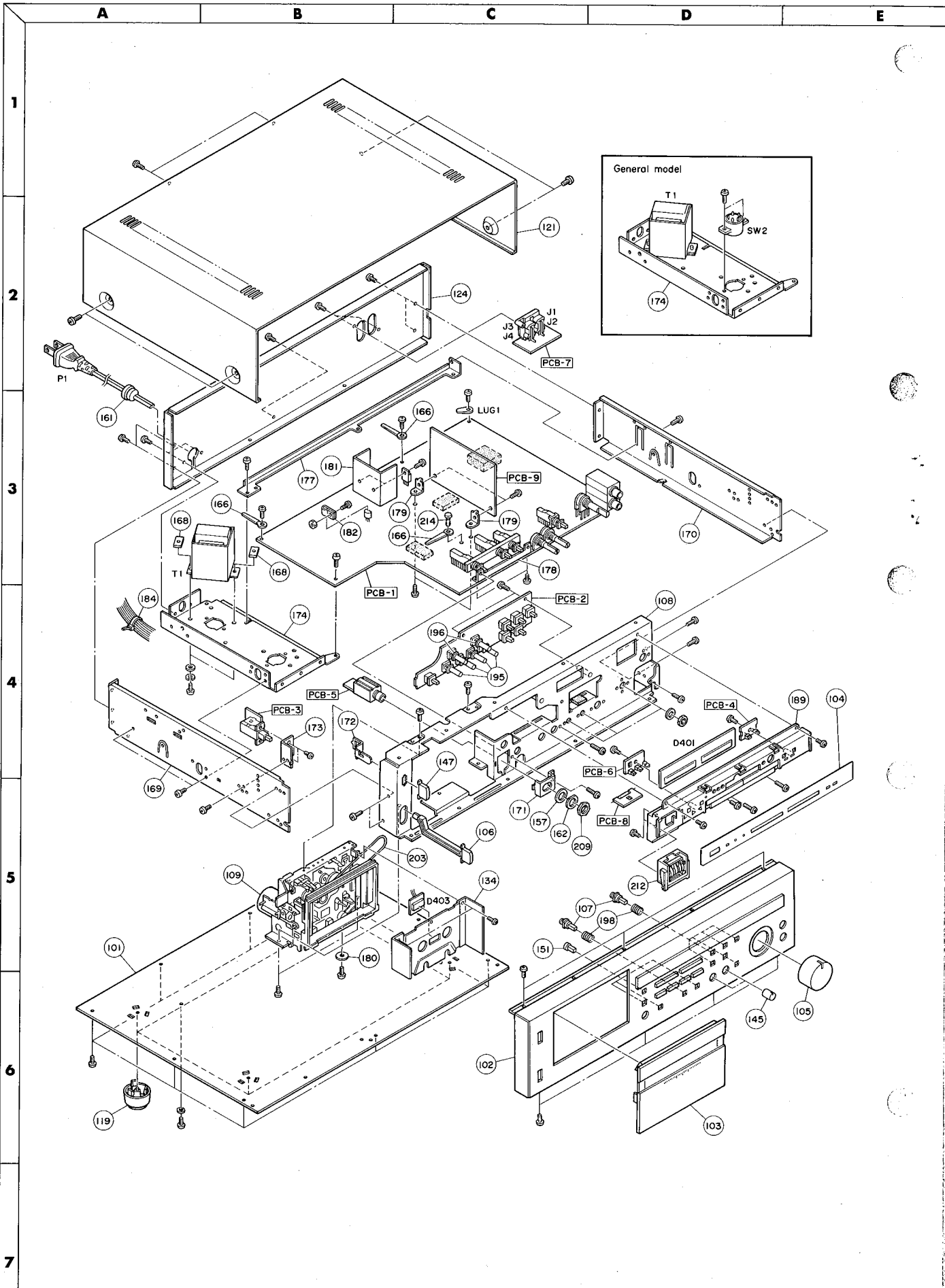

MARKETS

U: U.S.A. model
A: Canada model
G: General model
GM: General model Military version
B: Australia model
GB: General model Black Face version
GMB: General model Military Black Face version

GENERAL UNIT PARTS LIST

Ref. No.	Part No.	Description
102	A443-CD291B	Front Panel Assembly (Includes: Cassette Control Buttons) (GB, GMB)
103	A452-CD291B	Cassette Door Assembly (GB, GMB)
104	A514-CD291B	Plate Assembly, LED Level Display
105	A630-CD291B	Knob Assembly, Input Level (GB, GMB)
109	3112-12801	Cassette Tape Recorder Mechanical Assembly
121	1414-03601	Cabinet Top
124	1424-07010	Cabinet Back (G, GM, B, GB, GMB)
134	1514-15401	Dressing Plate
145	1634-02702	Knob, Bias Fine Trim, Input Balance (GB, GMB)
172	2219-7985	Bracket, Eject
180	2219-7755	Bracket, Cassette Mechanism
189	2240-7181	Holder, LED Level Display

ELECTRICAL PARTS LIST

Ref. No.	Part No.	Description
CHASSIS MISCELLANEOUS		
P1	4161-71185	AC Line Cord (B)
J805	4163-70996	Connector with Lead Wire, 8-Pin
	4474-29	AC Adaptor (GM only)
PCB-1 MAIN P.C. BOARD		
RESISTOR		
R733	5102-2204715	22 Ω , \pm 2%, 1/4W, Fuse
CAPACITORS		
C55	5342-335F0951	3.3 μ F, \pm 20%, 50V, Electrolytic
C103, 104	5345-226C0951	22 μ F, \pm 20%, 16V, Electrolytic
C111, 112	5345-106C0951	10 μ F, \pm 20%, 16V, Electrolytic
C213, 214	5345-684F0952	0.68 μ F, \pm 20%, 50V, Electrolytic
C219, 220	5342-225F0951	2.2 μ F, \pm 20%, 50V, Electrolytic
TRANSISTORS		
Q105, 106	5613-2320L(F)	2SC2320L (F)
Q107, 108	5611-999L(F)	2SA999L (F)
Q817	5613-2603(F)	2SC2603 (F)
COILS		
L101, 102	5995-363368	36mH

SCHEMATIC DIAGRAM

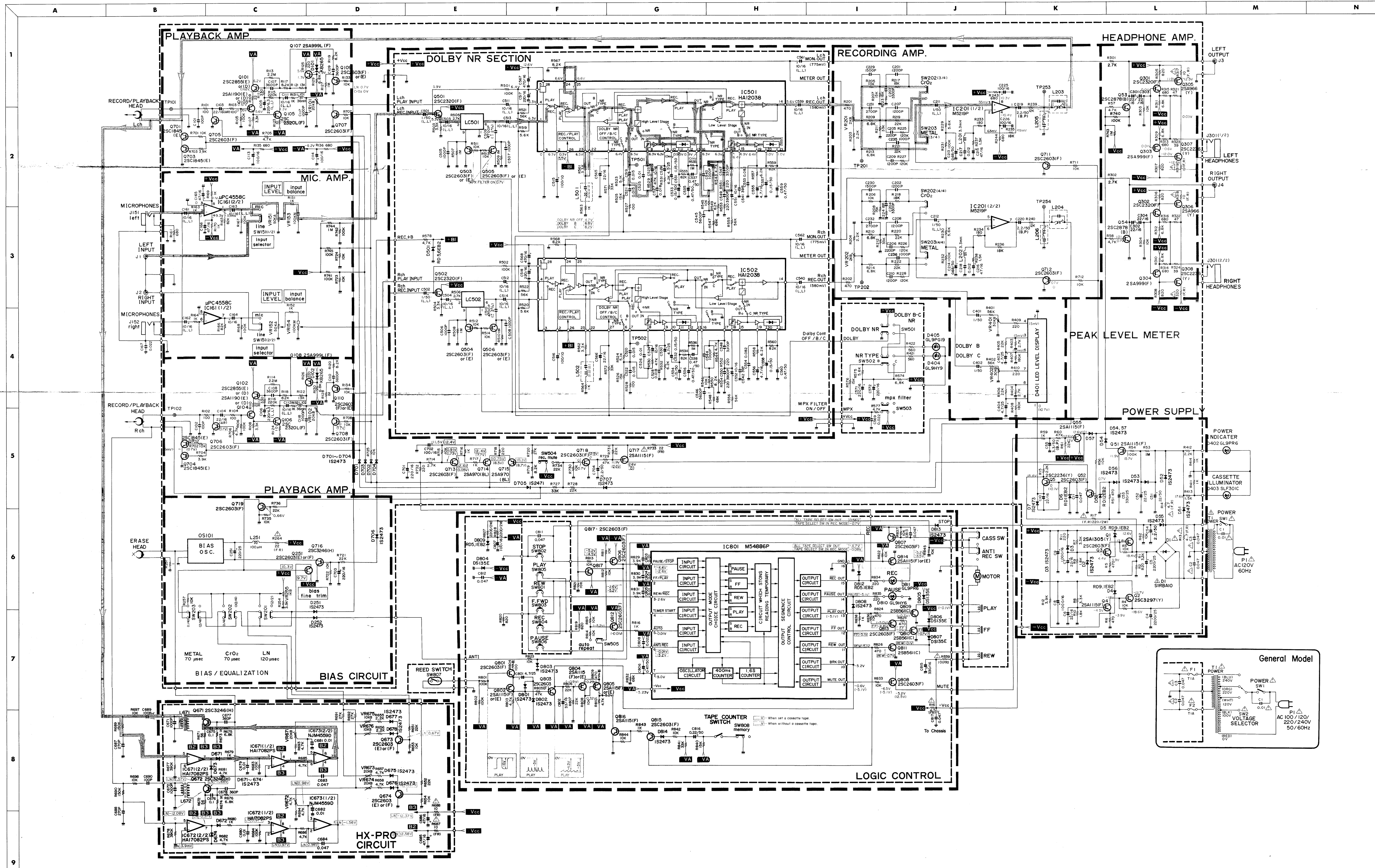

- RECORDING SIGNAL (Lch)
- PLAYBACK SIGNAL (Rch)
- 1. ALL RESISTANCE VALUES ARE IN Ω .
 $k\Omega = 1000\Omega$, $M\Omega = 1000k\Omega$
- 2. THE WATTAGE OF RESISTORS IS 1/4W UNLESS OTHERWISE NOTED.
- 3. ALL CAPACITANCE VALUES ARE IN μF UNLESS OTHERWISE NOTED. P = μF
- 4. V: DC VOLTAGE AT NO SIGNAL.
... V STOP MODE
... V PLAYBACK MODE
- 5. SAFETY REQUIREMENTS COMPONENTS IN ACCORDANCE WITH PRESENT SAFETY REGULATIONS. THESE COMPONENTS MUST ONLY BE REPLACED BY ORIGINAL PARTS.

SCHEMATIC DIAGRAM

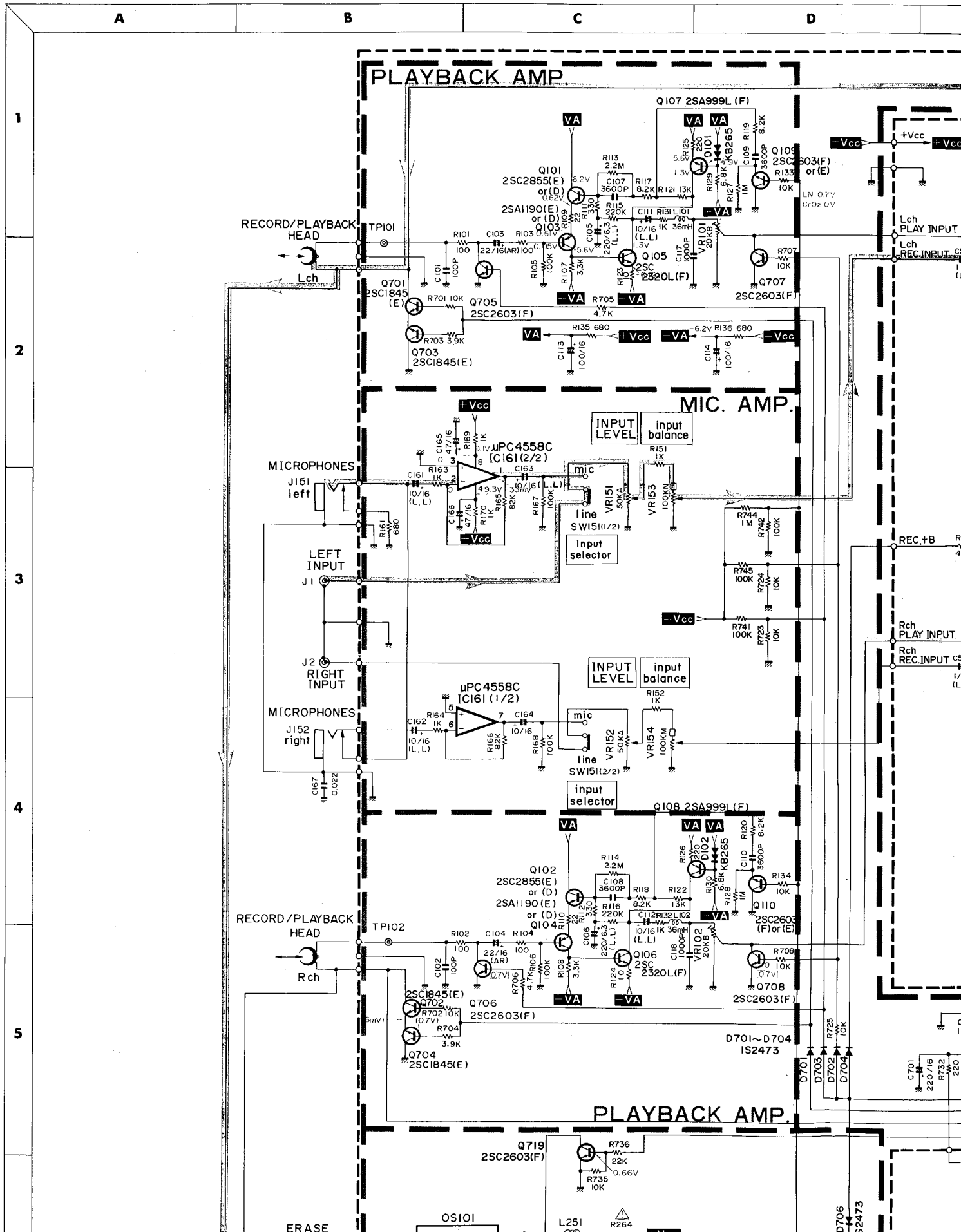

E

F

G

H

DOLBY NR SECTION

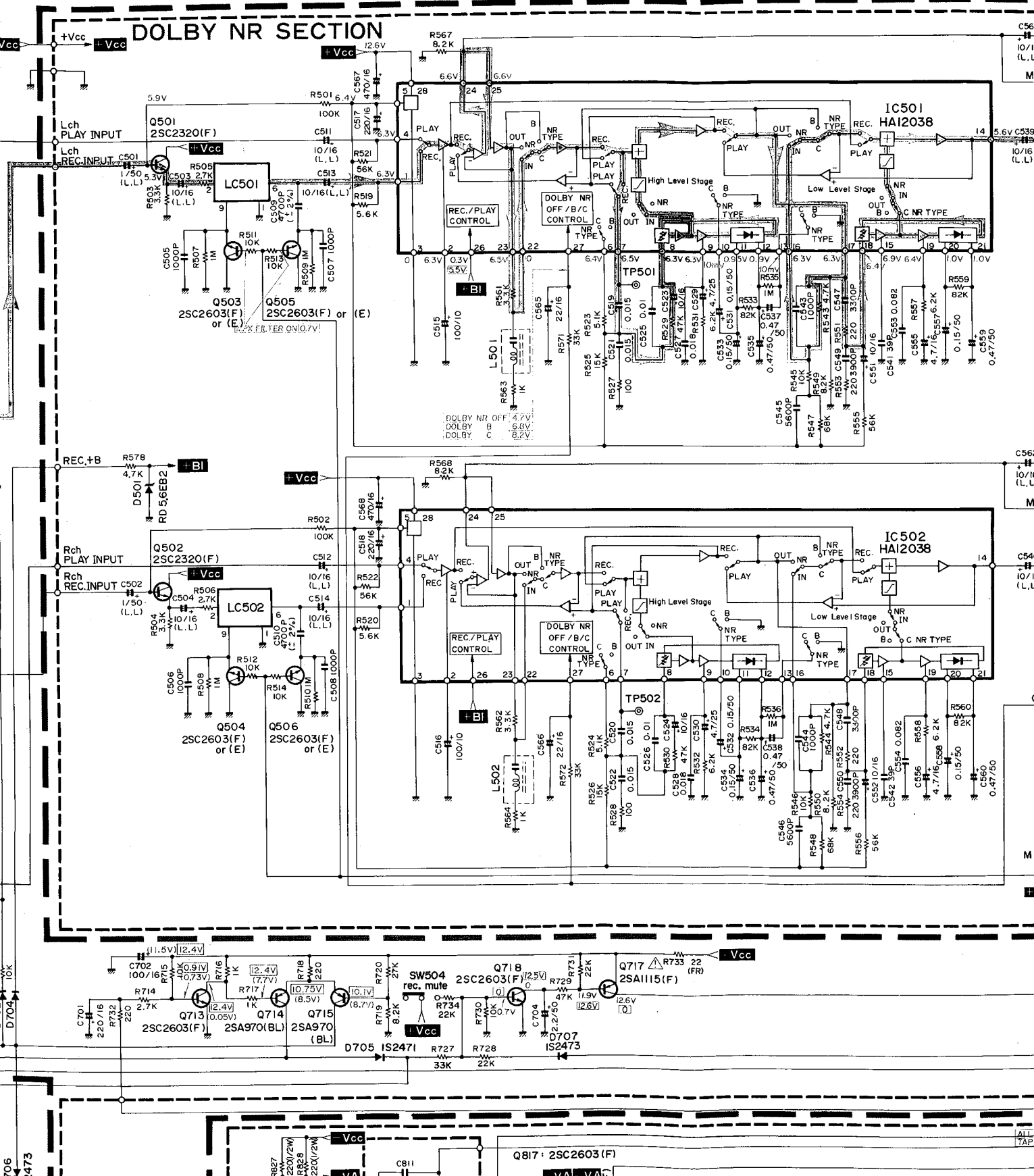

Q501 2SC2320(F)

Q503 2SC2603(F) or (E)

Q505 2SC2603(F) or (E)

Q502 2SC2320(F)

Q504 2SC2603(F) or (E)

Q506 2SC2603(F) or (E)

Q701 2SC2603(F)

Q713 2SA970(BL)

Q714 2SA970(BL)

Q715 2SA970(BL)

Q817 2SC2603(F)

IC501 HAI2038

IC502 HAI2038

TP501

TP502

DOLBY NR OFF/B/C CONTROL
DOLBY B 6.7V
DOLBY C 8.2V

DOLBY NR OFF/B/C CONTROL
DOLBY B 6.7V
DOLBY C 8.2V

C56
10/16
(L, L)

C539
10/16
(L, L)

C568
10/16
(L, L)

C54
10/16
(L, L)

C54
10/16
(L, L)

ATT
TAP

H

I

J

K

L

RECORDING AMP.

HEADPHONE

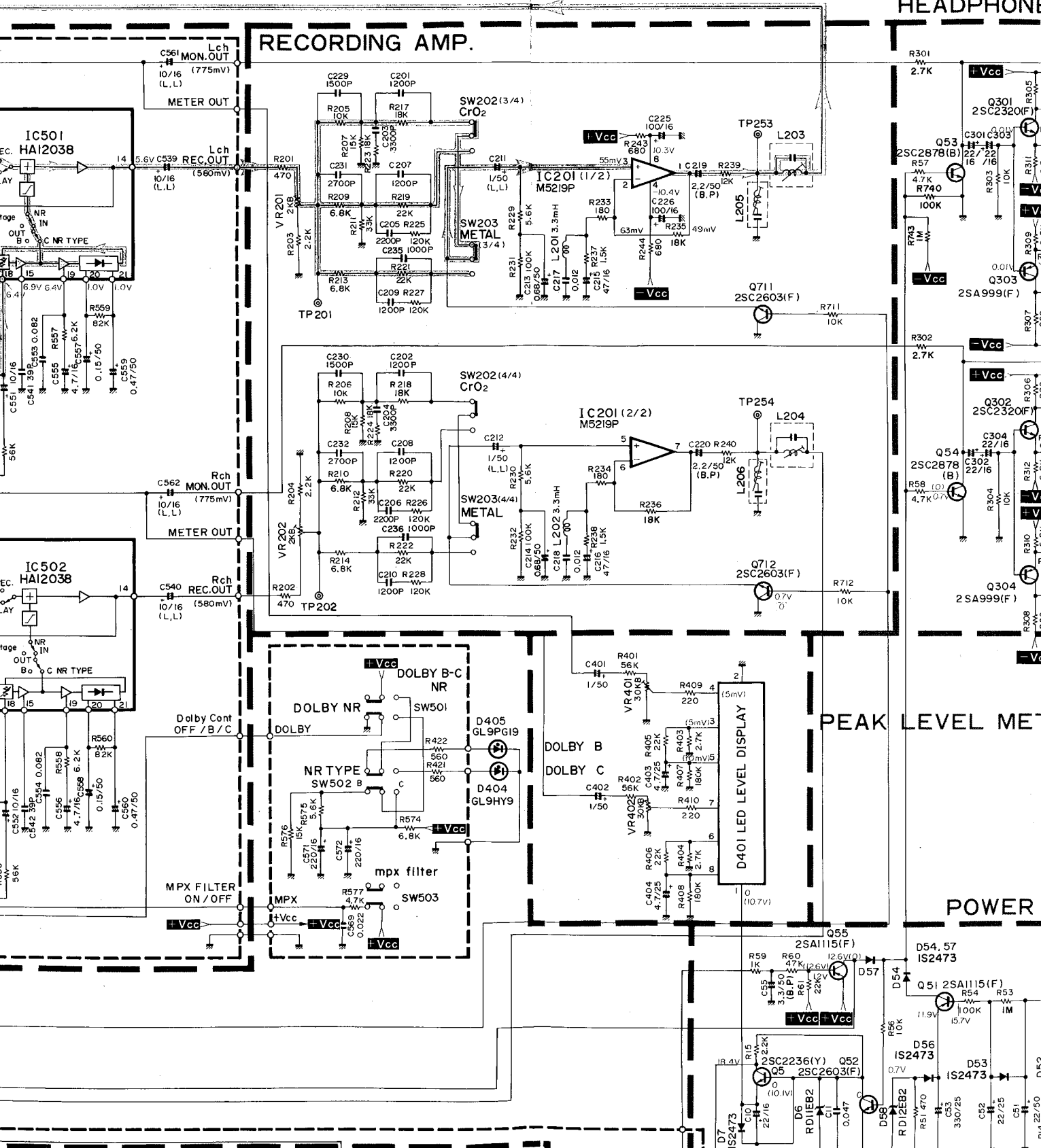

[ALL TAPE SELECT SW OUT - 0.56V]
 TAPE SELECT SW IN REC. MODE - 0.7V

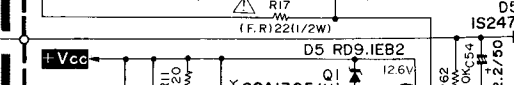
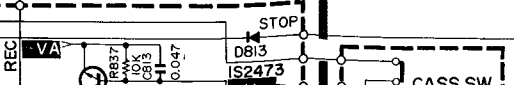

K

L

M

N

HEADPHONE AMP.

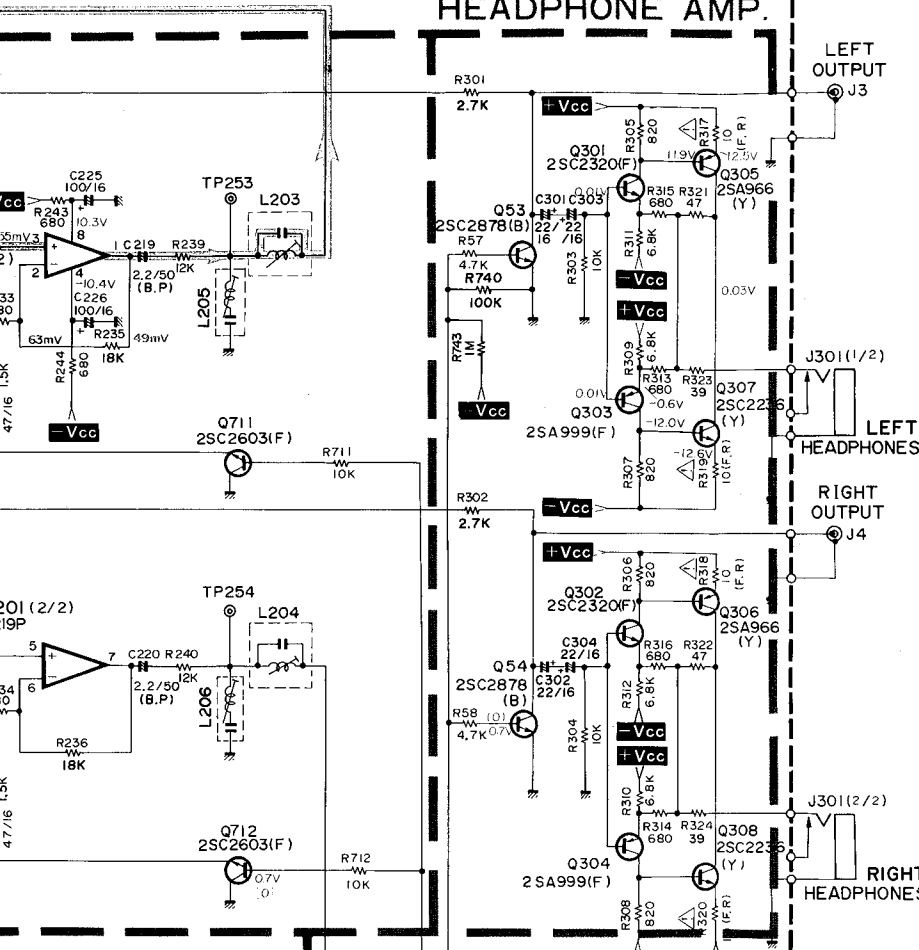

PEAK LEVEL METER

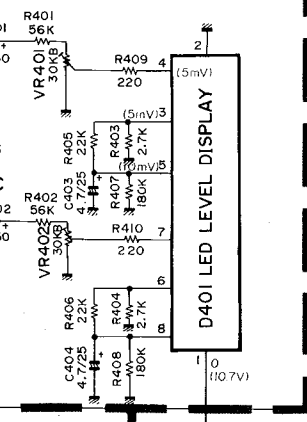

POWER SUPPLY

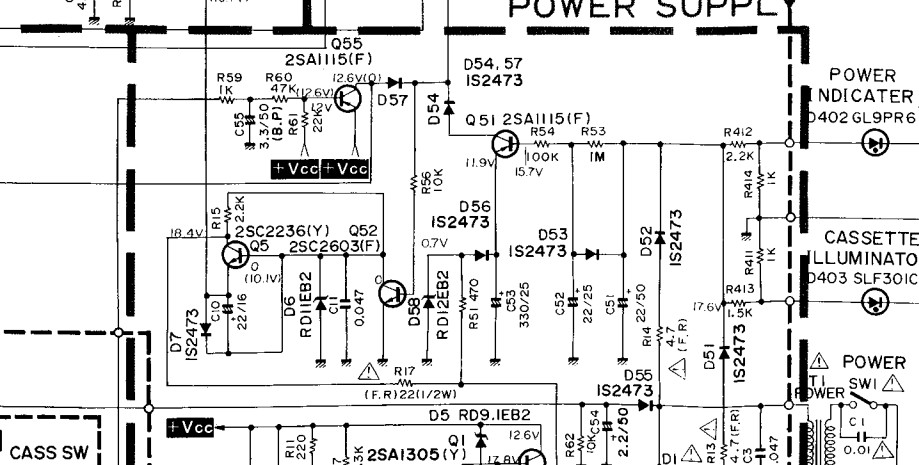

5

6

7

8

9

10

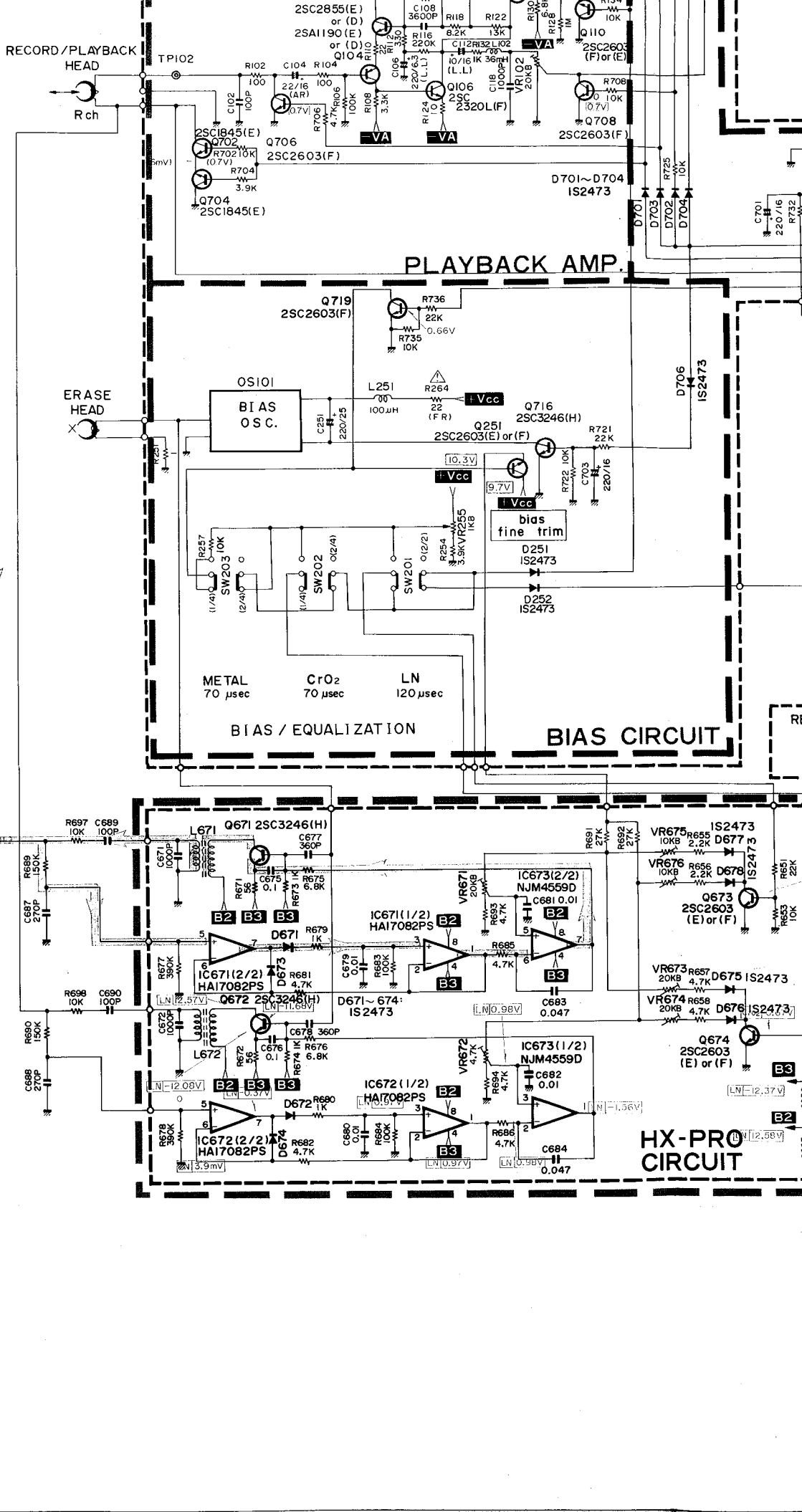

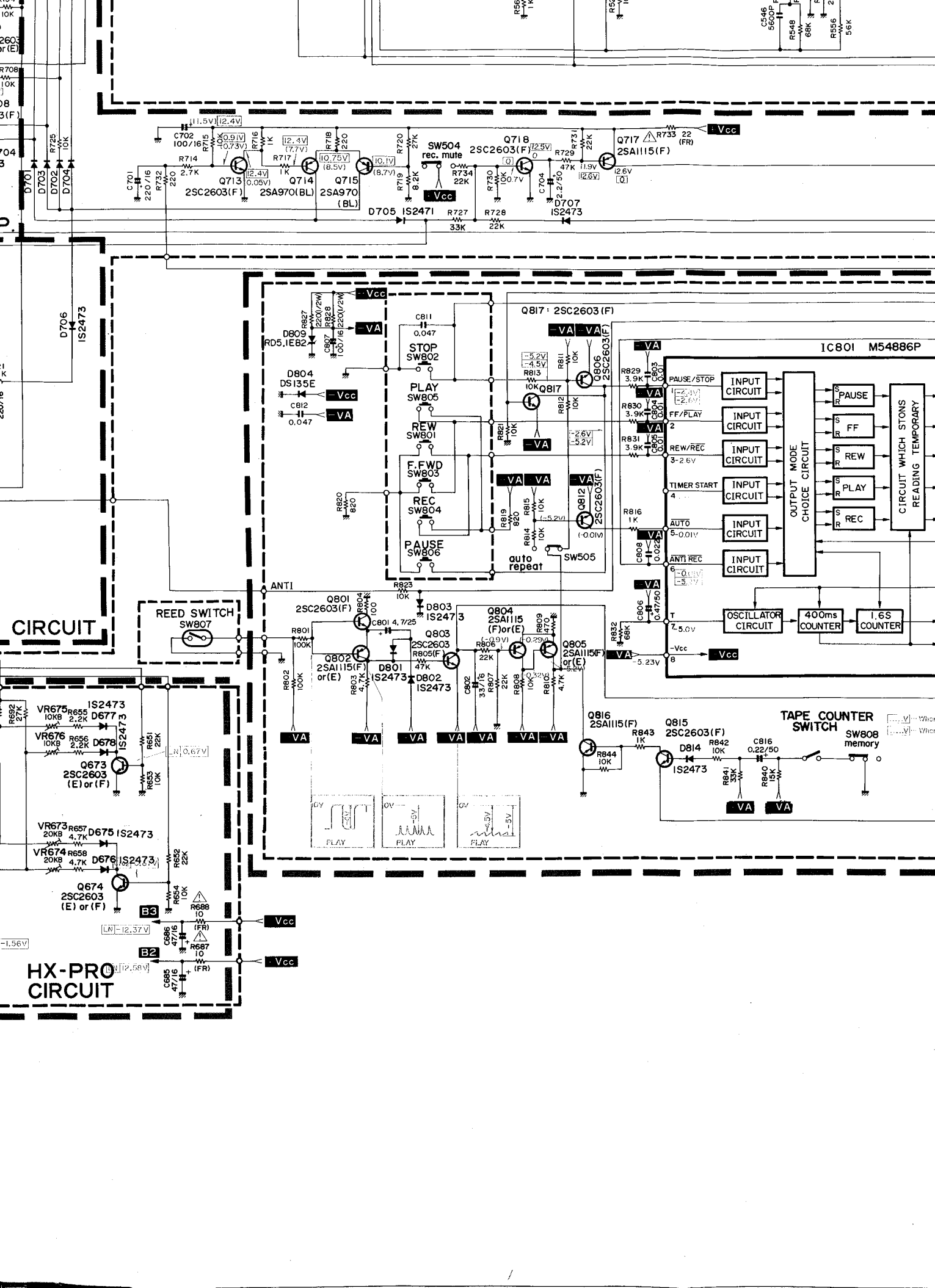

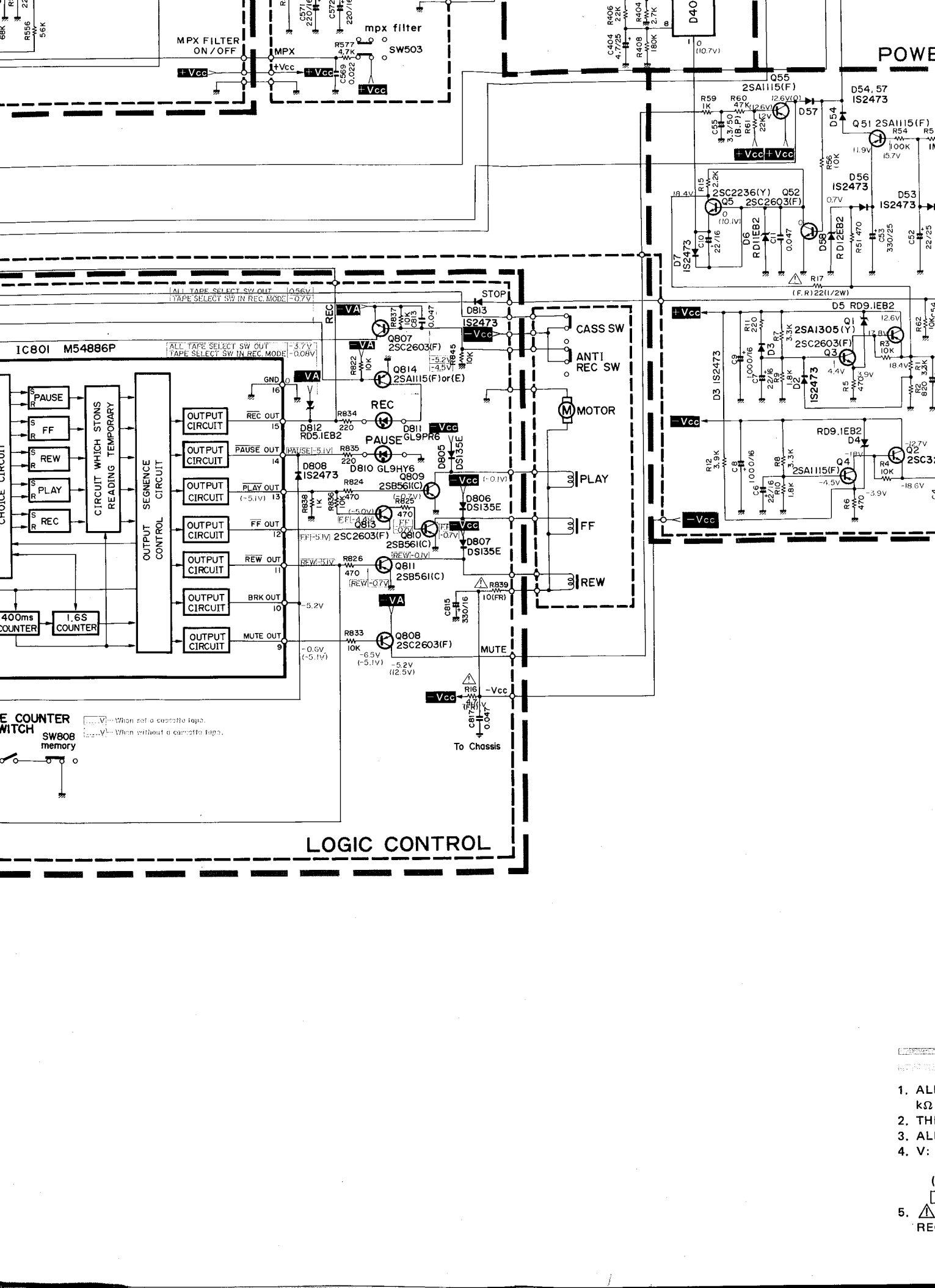

ALL TAPE SELECT SW OUT -0.56V
 TAPE SELECT SW IN REC. MODE -0.7V

ALL TAPE SELECT SW OUT -3.7V
 TAPE SELECT SW IN REC. MODE -0.6V

IC801 M54886P

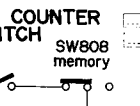

When set a cassette tape.
 When without a cassette tape.

LOGIC CONTROL

1. AL
2. TH
3. AL
4. V:
5. △

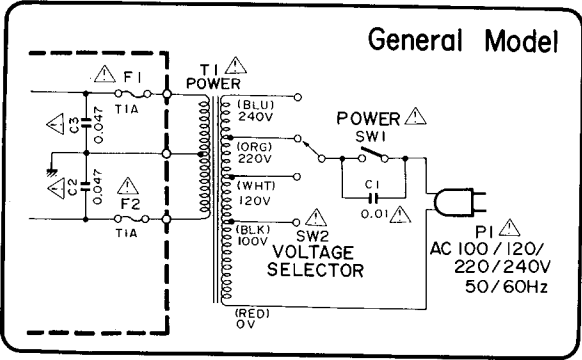
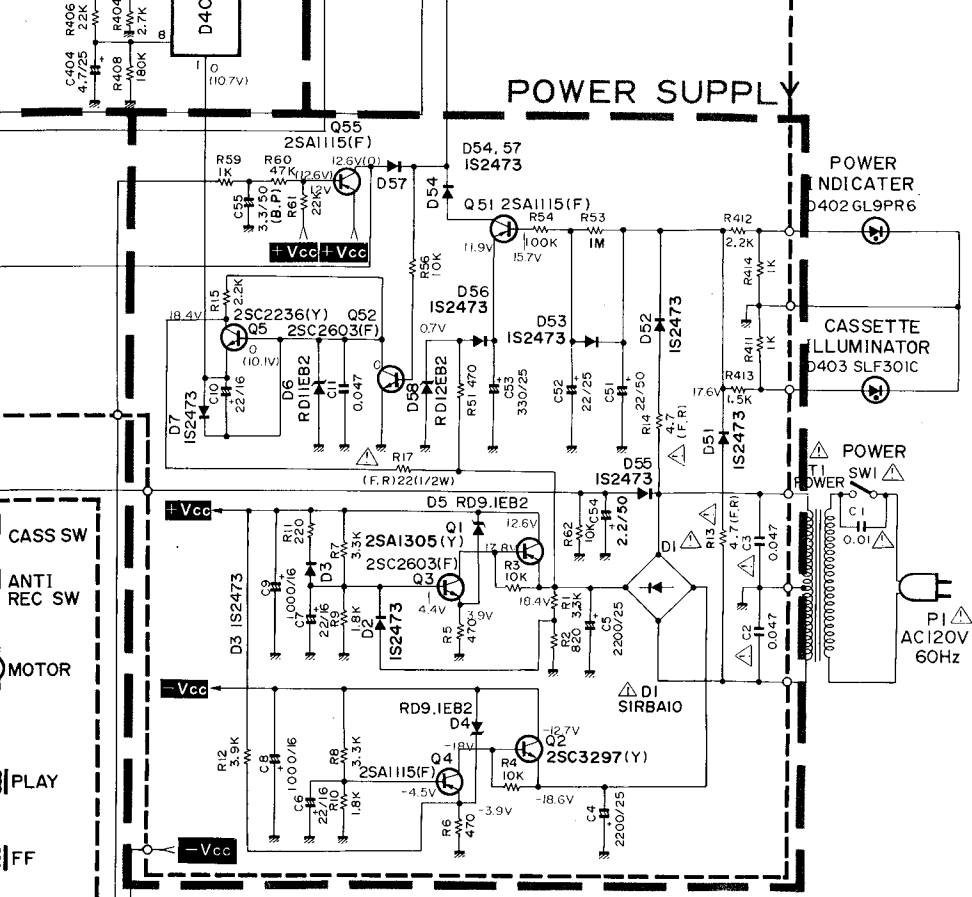

..... RECORDING SIGNAL (Lch)
 PLAYBACK SIGNAL (Rch)

1. ALL RESISTANCES VALUES ARE IN Ω .
 $k\Omega = 1000\Omega$, $M\Omega = 1000 k\Omega$
2. THE WATTAGE OF RESISTORS IS 1/4W UNLESS OTHERWISE NOTED.
3. ALL CAPACITANCES VALUES ARE IN μF UNLESS OTHERWISE NOTED. $P = \mu\mu F$
4. V: DC VOLTAGE AT NO SIGNAL.
 ... V STOP MODE
 (... V) PLAYBACK MODE
 (... V) RECORDING MODE
5. Δ SAFETY-REQUIREMENTS COMPONENTS IN ACCORDANCE WITH PRESENT SAFETY REGULATIONS. THESE COMPONENTS MUST ONLY BE REPLACED BY ORIGINAL PARTS.

WIRING DIAGRAM

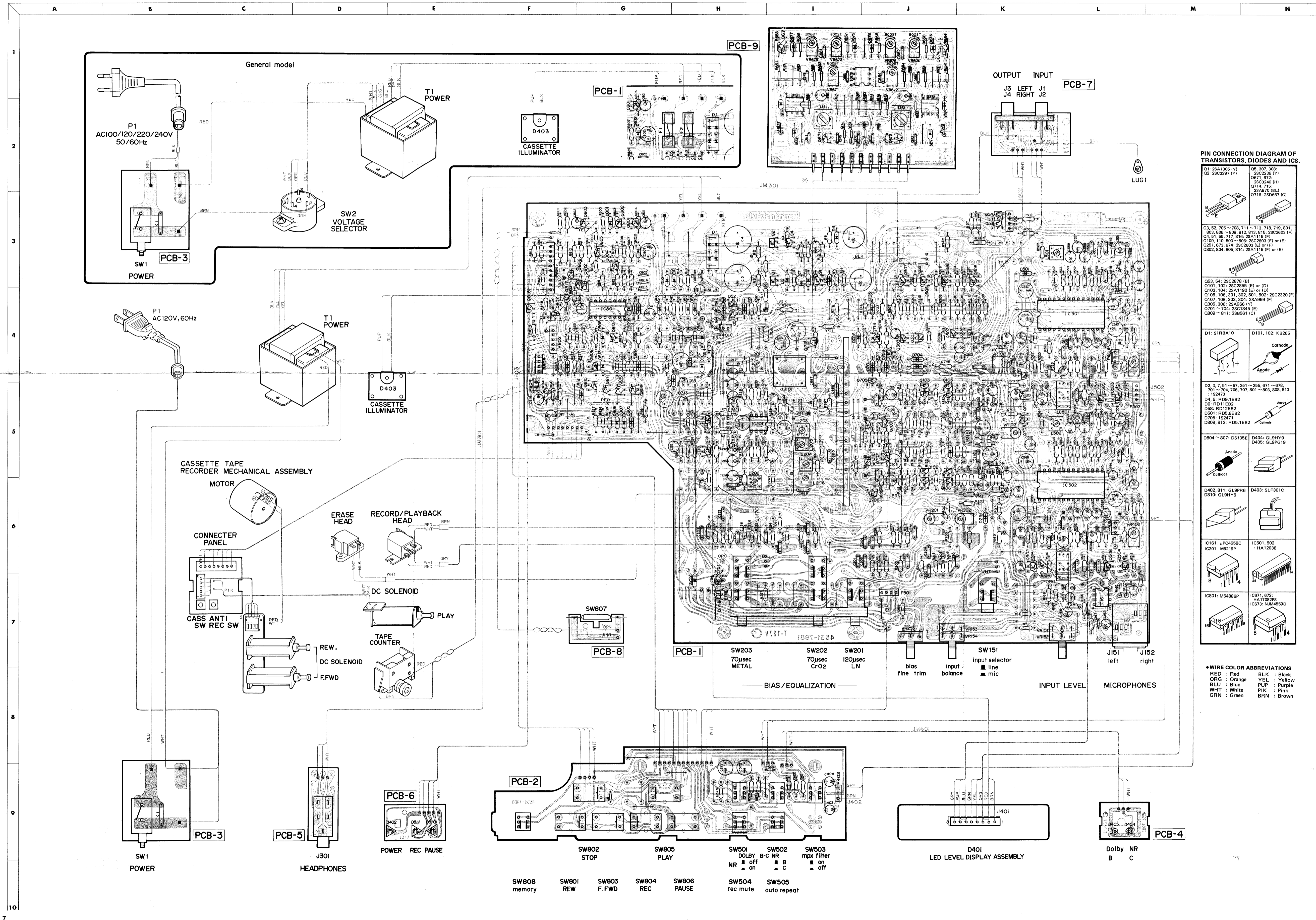

PIN CONNECTION DIAGRAM OF TRANSISTORS, DIODES AND ICs.

Q1: 2SA1306 (Y)	Q5: 307, 308: 2SC2238 (Y)
Q2: 2SC3297 (Y)	Q6: 2SC246 (H)
	Q7: 714, 715: 2SA970 (BL)
	Q716: 2SC667 (C)
Q3, 52, 705 ~ 708, 711 ~ 713, 718, 719, 801, 803, 806 ~ 808, 812, 813, 815: 2SC2603 (F)	
Q4, 51, 55, 717, 816: 2SA1115 (F)	
Q109, 110, 503 ~ 506: 2SC2803 (F) or (E)	
Q281, 673, 674: 2SC2603 (E) or (F)	
Q802, 804, 805, 814: 2SA1115 (F) or (E)	
Q53, 54: 2SC2878 (B)	
Q101, 102: 2SC2855 (E) or (D)	
Q103, 104: 2SA1190 (E) or (D)	
Q105, 106, 301, 302, 501, 502: 2SC2320 (F)	
Q107, 108, 303, 304: 2SA999 (F)	
Q305, 306: 2SA966 (Y)	
Q701 ~ 704: 2SC1845 (E)	
Q809 ~ 811: 2SB651 (C)	
D1: 1SRBA10	D101, 102: KB265
	Cathode
	Anode
D2, 3, 7, 51 ~ 57, 251 ~ 255, 671 ~ 678, 701 ~ 704, 706, 707, 801 ~ 803, 806, 813: 1S2473	
D4, 5: RD9.1EB2	
D6: RD11EB2	
D8: RD12EB2	
D501: RD5.6EB2	
D705: 1S2471	
D809, 812: RD6.1EB2	
D804 ~ 807: DS135E	D404: GL9HY9
	D405: GL9PG19
	Anode
	Cathode
D402, 811: GL9PP6	D403: SLF301C
D810: GL9HY6	
IC161: μ PC4558C	IC501, 502: HA12038
IC201: M5219P	
IC801: M54886P	IC671, 672: HA170629S
	IC673: NJM4599D

WIRING DIAGRAM

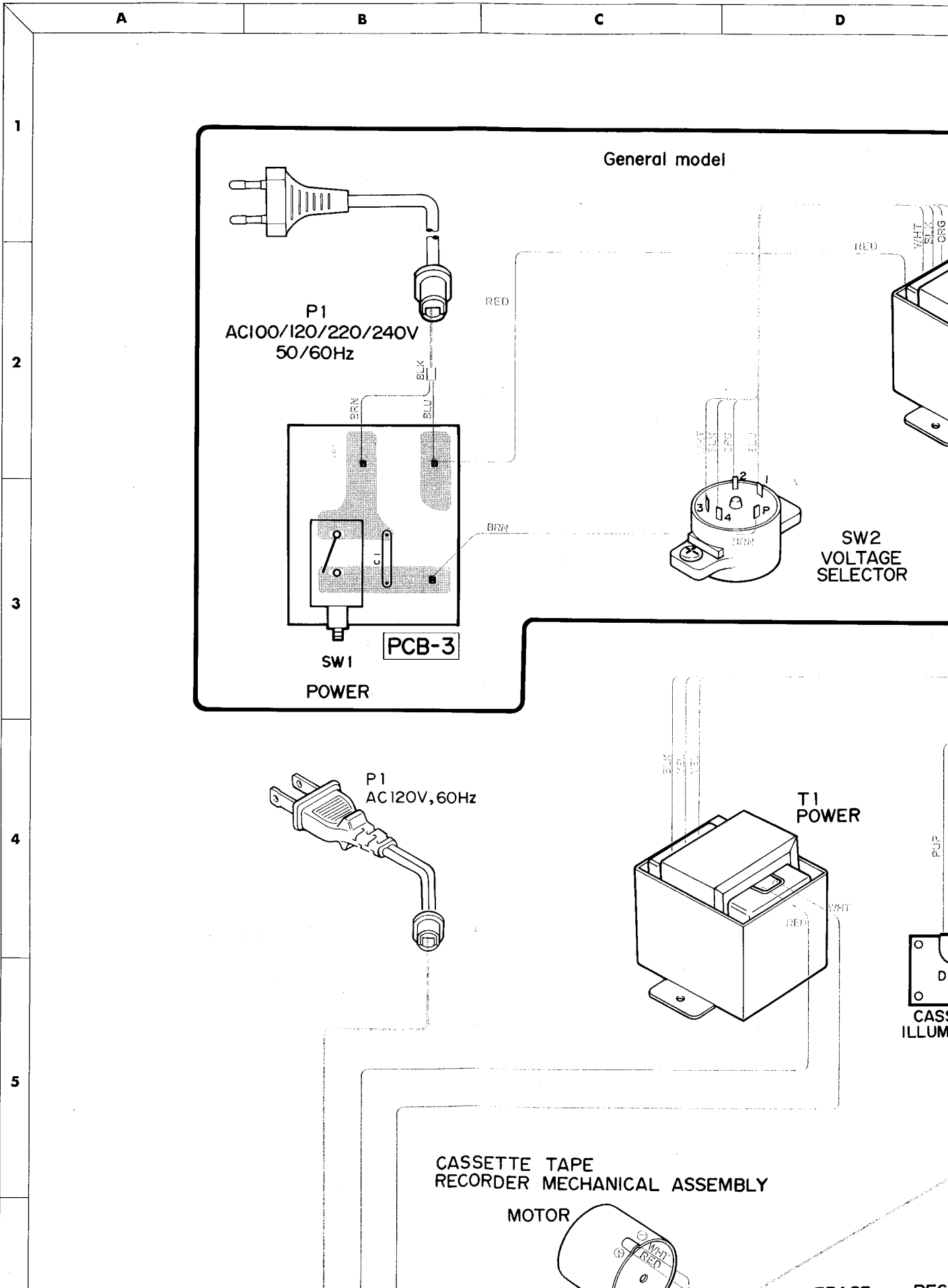

E

F

G

H

PCB-9

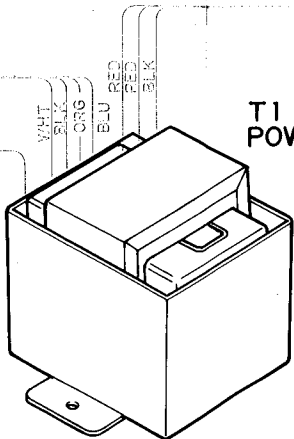

T1
POWER

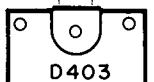

D403
CASSETTE
ILLUMINATOR

PCB-1

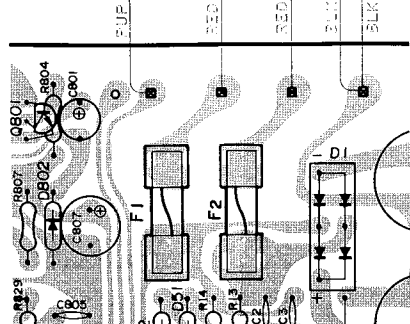

2
PAGE
ECTOR

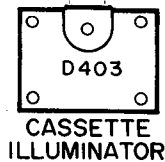

D403
CASSETTE
ILLUMINATOR

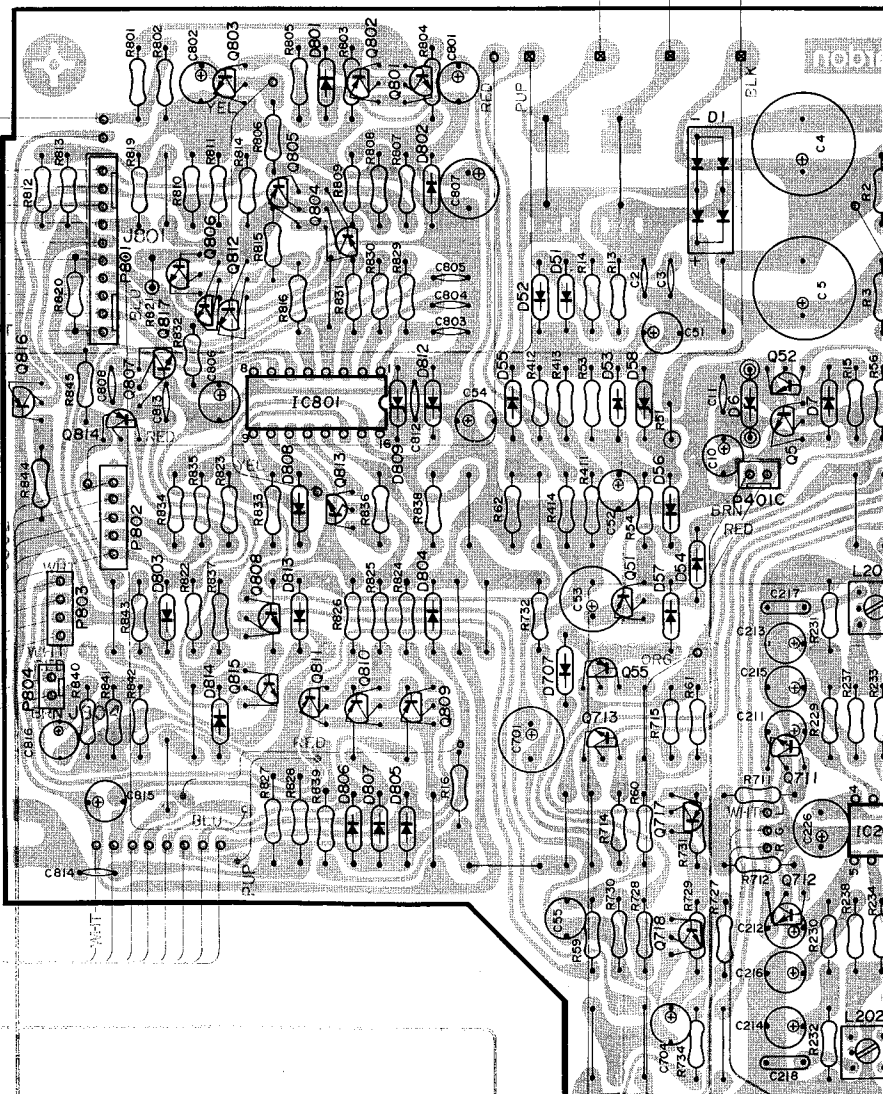

RECORD/PLAYBACK

PCB-9

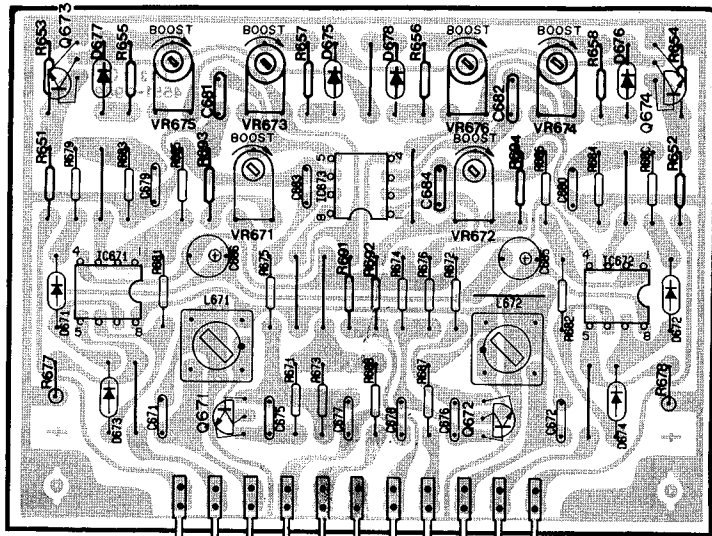

OUTPUT INPUT
J3 LEFT J1
J4 RIGHT J2

PCB-7

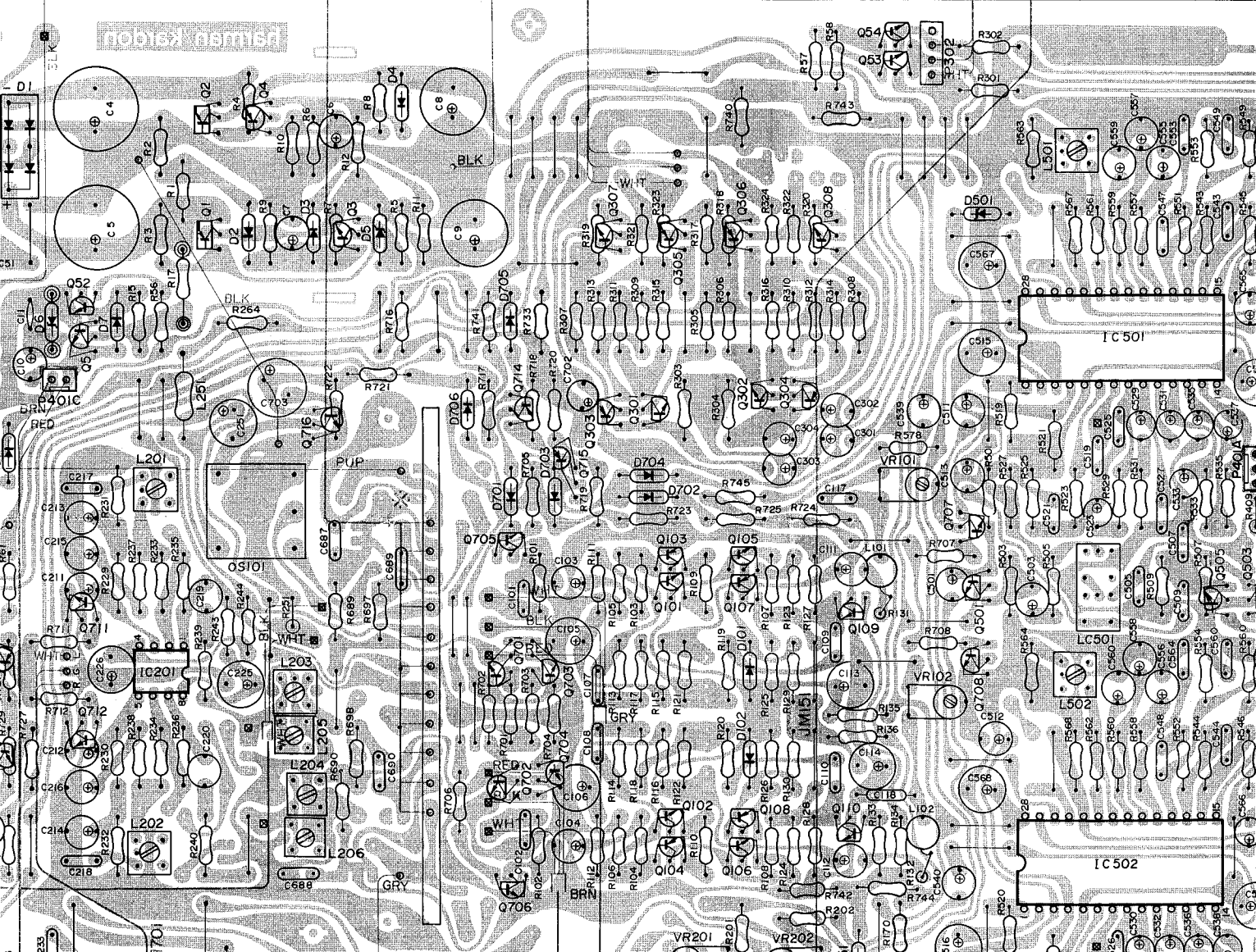
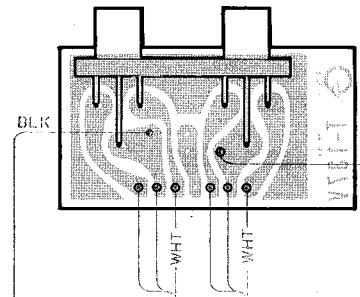

K

L

M

N

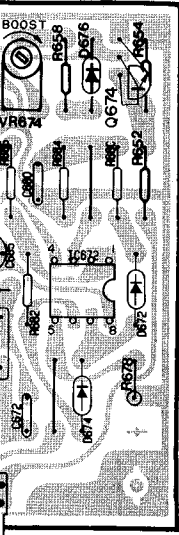

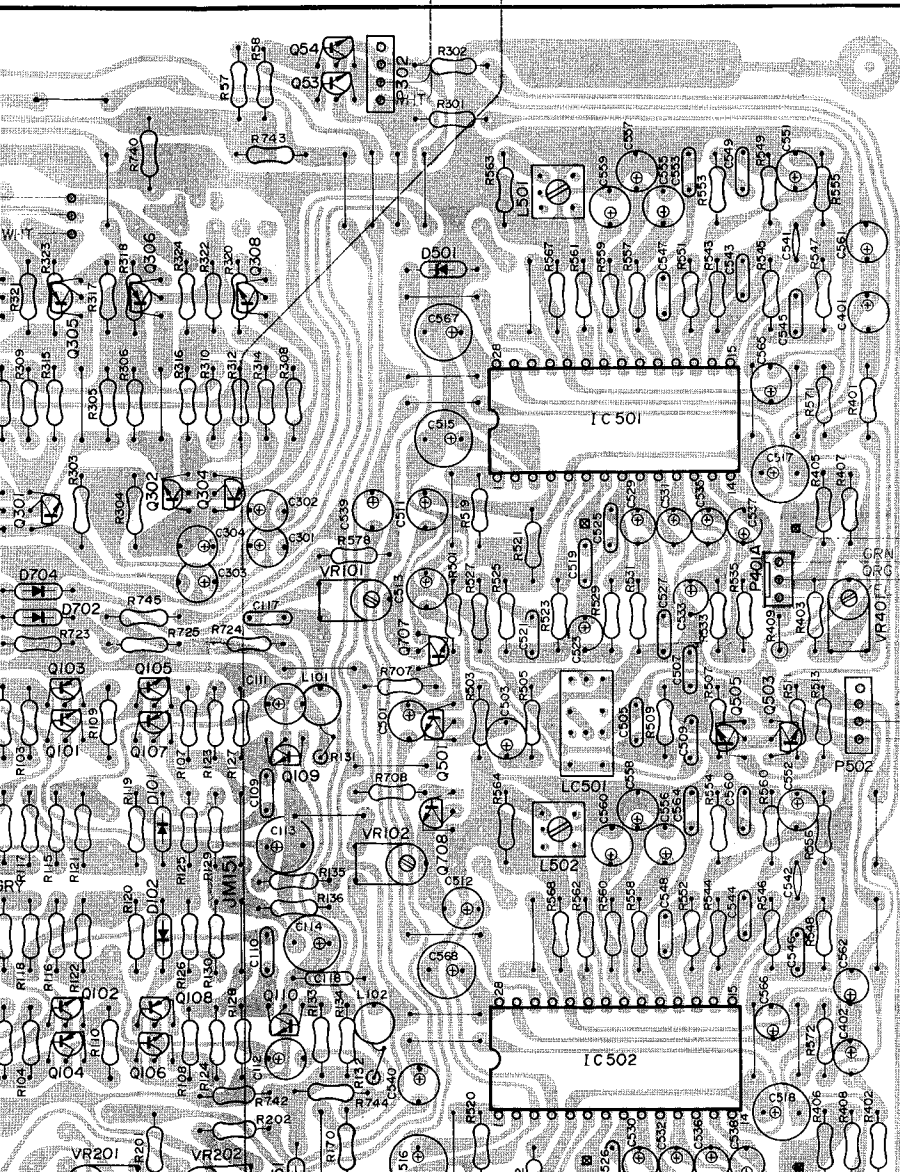
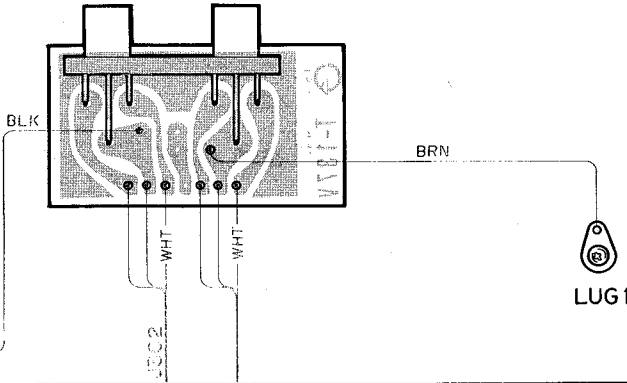

OUTPUT INPUT
 J3 LEFT J1
 J4 RIGHT J2

PCB-7

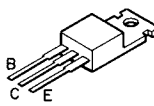
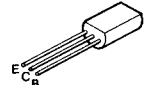
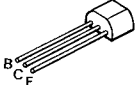
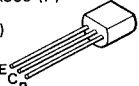
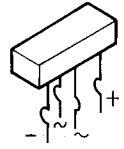
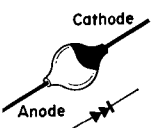
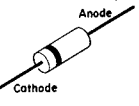
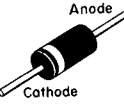
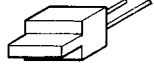

PIN CONNECTION DIAGRAM OF TRANSISTORS, DIODES AND ICs.

<p>Q1: 2SA1305 (Y) Q2: 2SC3297 (Y)</p> 	<p>Q5, 307, 308: 2SC2236 (Y) Q671, 672: 2SC3245 (H) Q714, 715: 2SA970 (BL) Q716: 2SD667 (C)</p> 
<p>Q3, 52, 705 ~ 708, 711 ~ 713, 718, 719, 801, 803, 806 ~ 808, 812, 813, 815: 2SC2603 (F) Q4, 51, 55, 717, 816: 2SA1115 (F) Q109, 110, 503 ~ 506: 2SC2603 (F) or (E) Q251, 673, 674: 2SC2603 (E) or (F) Q802, 804, 805, 814: 2SA1115 (F) or (E)</p> 	
<p>Q53, 54: 2SC2878 (B) Q101, 102: 2SC2855 (E) or (D) Q103, 104: 2SA1190 (E) or (D) Q105, 106, 301, 302, 501, 502: 2SC2320 (F) Q107, 108, 303, 304: 2SA999 (F) Q305, 306: 2SA966 (Y) Q701 ~ 704: 2SC1845 (E) Q809 ~ 811: 2SB561 (C)</p> 	
<p>D1: 1S1BA10</p> 	<p>D101, 102: KB265</p> 
<p>D2, 3, 7, 51 ~ 57, 251 ~ 255, 671 ~ 678, 701 ~ 704, 706, 707, 801 ~ 803, 808, 813 : 1S2473 D4, 5: RD9.1EB2 D6: RD11EB2 D58: RD12EB2 D501: RD5.6EB2 D705: 1S2471 D809, 812: RD5.1EB2</p> 	
<p>D804 ~ 807: DS135E</p> 	<p>D404: GL9HY9 D405: GL9PG19</p> 
<p>D402, 811: GL9PR6 D810: GL9HY6</p> 	<p>D403: SLF301C</p> 

5

6

7

8

9

10

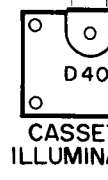

CASSETTE TAPE
RECORDER MECHANICAL ASSEMBLY

MOTOR

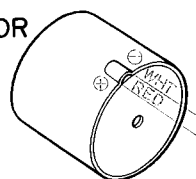

ERASE
HEAD

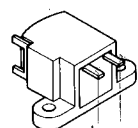

RECOR

CONNECTER
PANEL

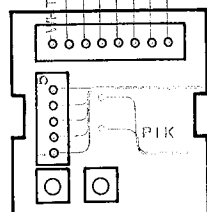

DC SO



CASS ANTI
SW REC SW

TAPE
COUNT

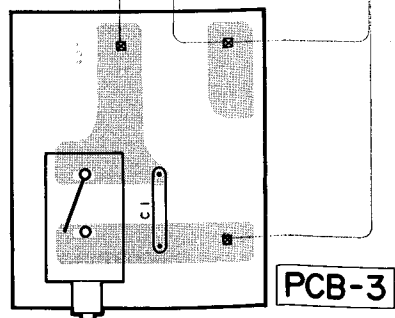
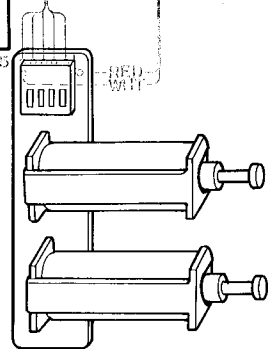

SW1
POWER

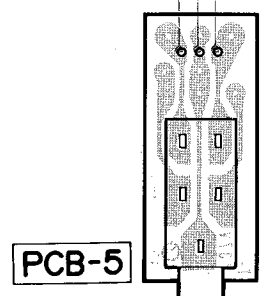

J301
HEADPHONES

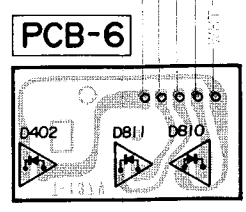
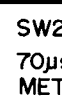
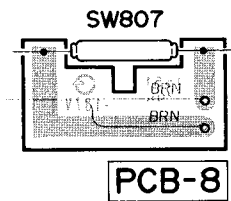
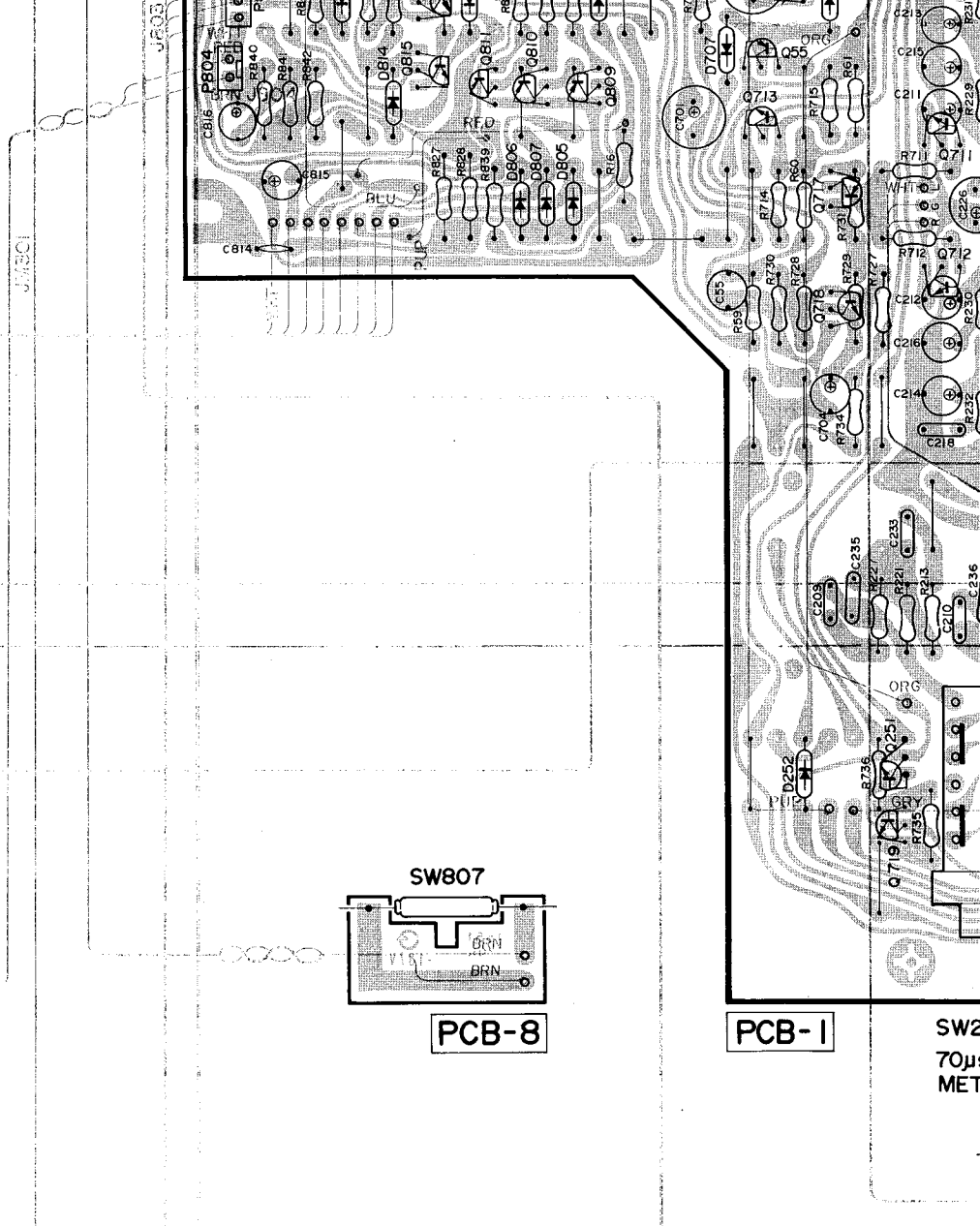
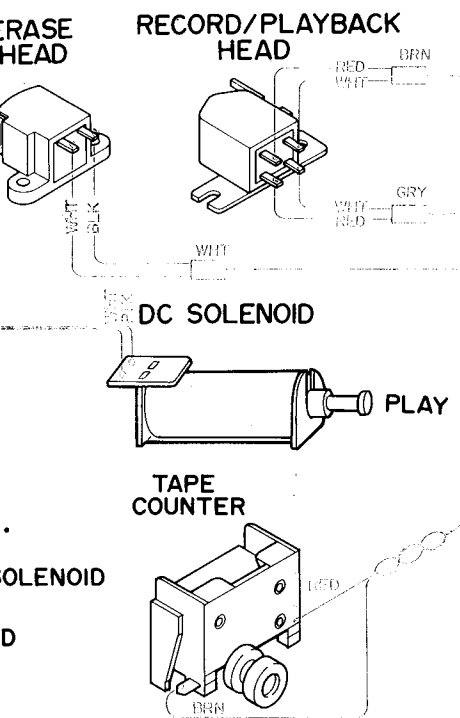
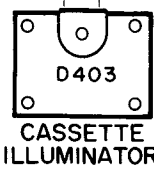

POWER REC PAUSE

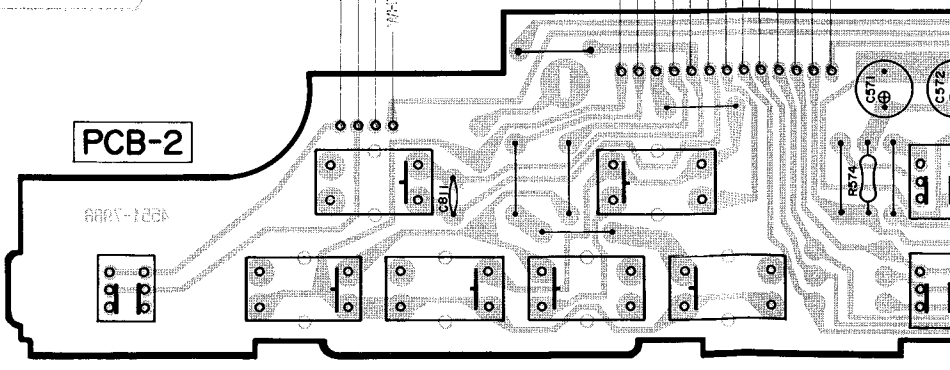

SW802
STOP

SW805
PLAY

SW5
D
NR

SW808
memory

SW801
REW

SW803
F.FWD

SW804
REC

SW806
PAUSE

SW5
rec m

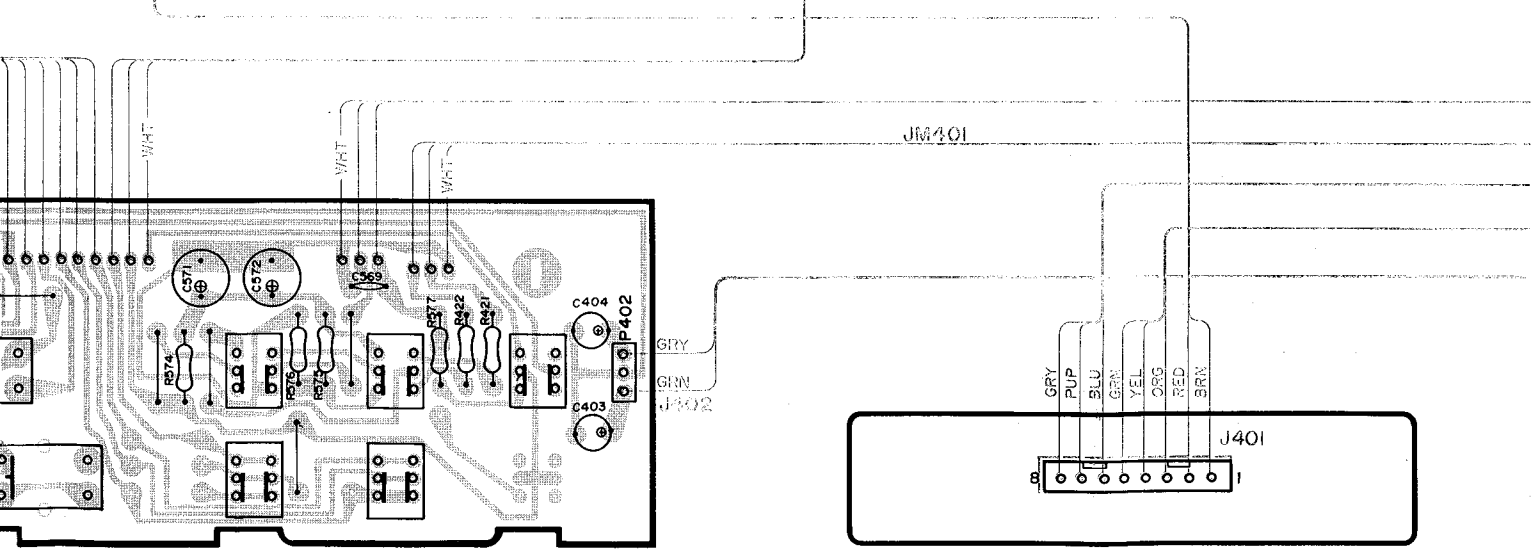
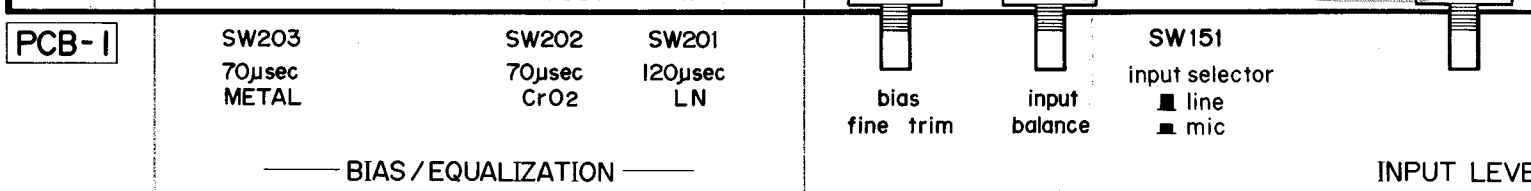
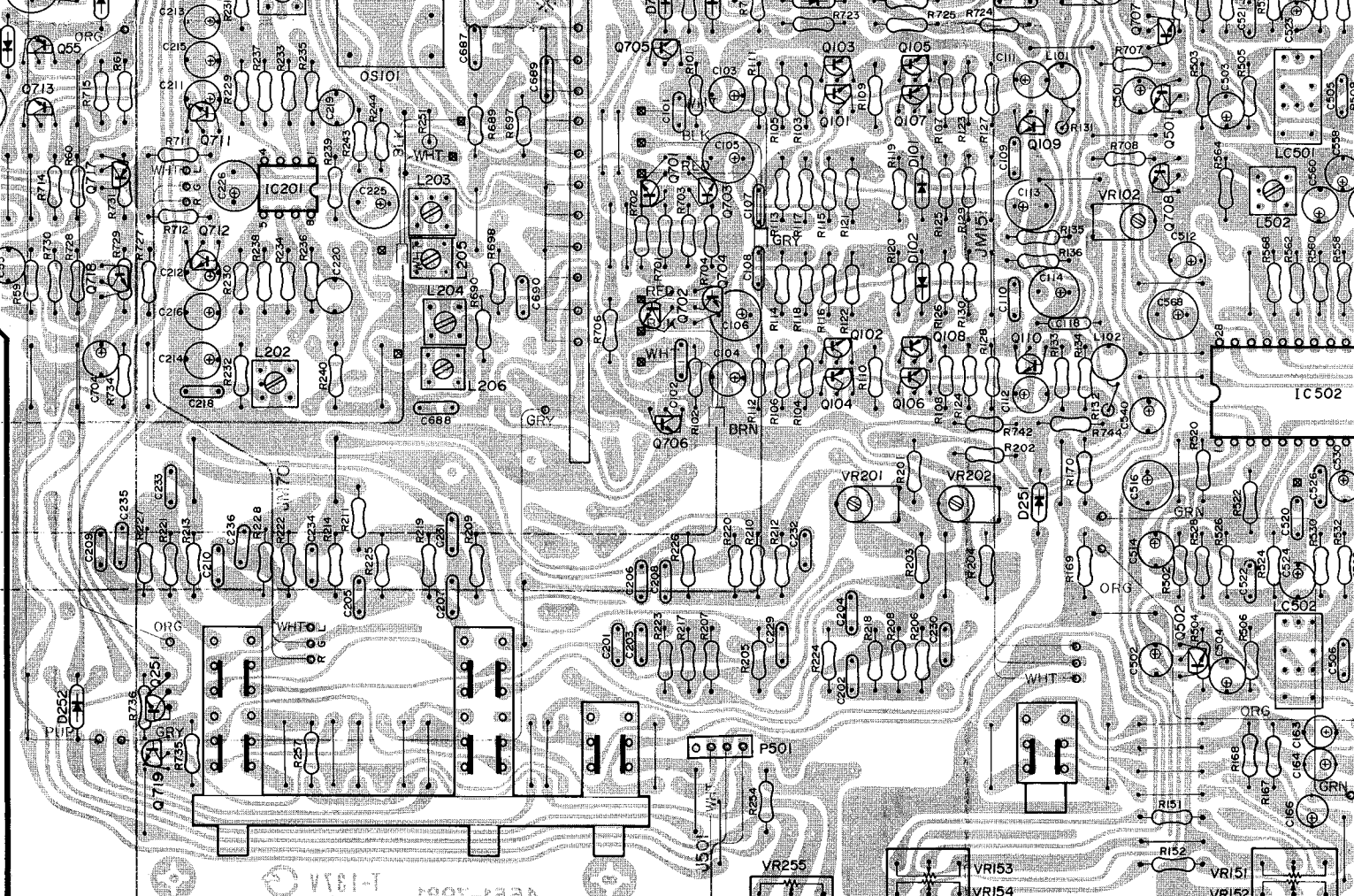

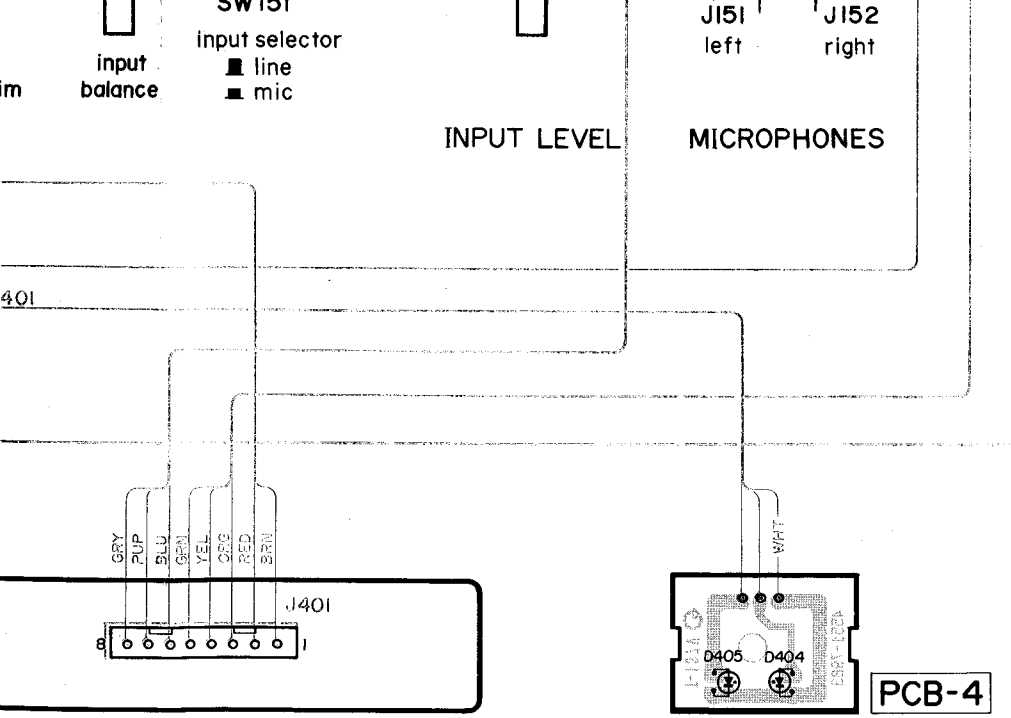
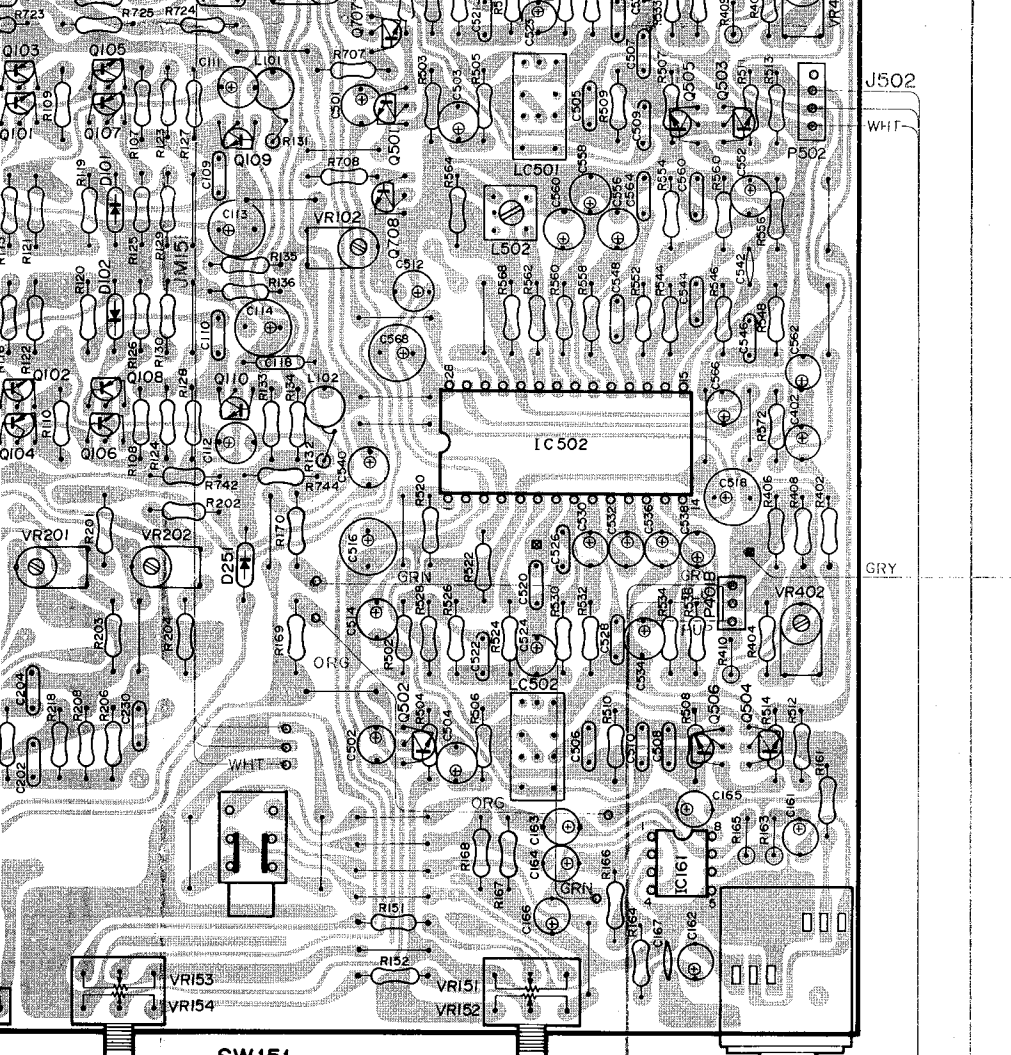

D2, 3, 7, 51 ~ 57, 251 ~ 255, 671 ~ 678, 701 ~ 704, 706, 707, 801 ~ 803, 808, 813 : 1S2473 D4, 5: RD9.1EB2 D6: RD11EB2 D58: RD12EB2 D501: RD5.6EB2 D705: 1S2471 D809, 812: RD5.1EB2	
D804 ~ 807: DS135E	D404: GL9HY9 D405: GL9PG19
D402, 811: GL9PR6 D810: GL9HY6	D403: SLF301C
IC161: μ PC4558C IC201: M5219P	IC501, 502 : HA12038
IC801: M54886P	IC671, 672: HA17082PS IC673: NJM4559D

- WIRE COLOR ABBREVIATIONS
- | | |
|--------------|--------------|
| RED : Red | BLK : Black |
| ORG : Orange | YEL : Yellow |
| BLU : Blue | PUP : Purple |
| WHT : White | PIK : Pink |
| GRN : Green | BRN : Brown |

D401
LED LEVEL DISPLAY ASSEMBLY

Dolby NR
B C

PCB-4